

STAGEDIRECT™

Active Direct Box with Mute



User Guide

Radial® StageDirect™

Active Direct Box with Mute

Table of Contents	Page
What is a direct box anyway	1
Features.....	2
Getting started with power and connections.....	3
Using the PAD and tuner output	4
Using the mute footswitch.....	5
Using the remote mute	5
Various remote footswitch setups	6
Remote control with the Radial SW2 footswitch	7
Using the high-pass filter	8
Using the polarity and phase reverse	9
Eliminating hum and buzz.....	10
Specifications.....	11
Radial Limited Warranty.....	Back Cover

INTRODUCTION

Congratulations on your purchase of the Radial StageDirect! The StageDirect combines a high quality Radial active direct box with an input channel select footswitch and a mute footswitch with separate tuner out that lets you tune in silence. This enables you to switch instruments and tune up without disrupting the audience. No more nasty popping noise that typically occurs while 'hot-swapping' your cable from one instrument to the next.

Designed to be super easy to use, the StageDirect will get you up and running in no time. That said, as with any new product that you get your hands (or feet) on, we recommend that you take a little time to read through the manual in order to familiarize yourself with the StageDirect so you can get the most out of it.

If you have any questions that are not covered in this manual, please consult the FAQ section on our web site as this is where we post the latest updates and questions from other users. If you still can't find what you are looking for, feel free to send us a note at info@radialeng.com and we will do our very best to reply in short order.

Now let's make some foot-stomping music!

WHAT IS A DIRECT BOX ANYWAY?

A direct box (aka a DI box) is a device that lets you interface hi-impedance instruments (hi-Z) like electric guitar, bass or keyboard with professional low impedance (lo-Z) PA and recording systems. Direct boxes, like the StageDirect, first split the unbalanced hi-Z instrument signal in order to send it to your amp and tuner. It simultaneously converts the instrument signal to a lo-Z balanced output that can connect to a professional audio system. Direct boxes like the StageDirect ensure the signal is delivered to the PA as faithfully as possible.

The hi-Z instrument cables you use to connect your instrument, amp and tuner, employ unbalanced 1/4" connectors at both ends. Hi-Z cables are particularly sensitive to noise caused by magnetic fields and tone-killing capacitance when extended beyond 6 meters (20'). To keep these instrument cables as short as possible, the StageDirect is usually placed at your feet or near your amp and the lo-Z balanced XLR output is used to extend your instrument signal to the PA system to 100 meters (300') or more by lowering the impedance and balancing the signal.

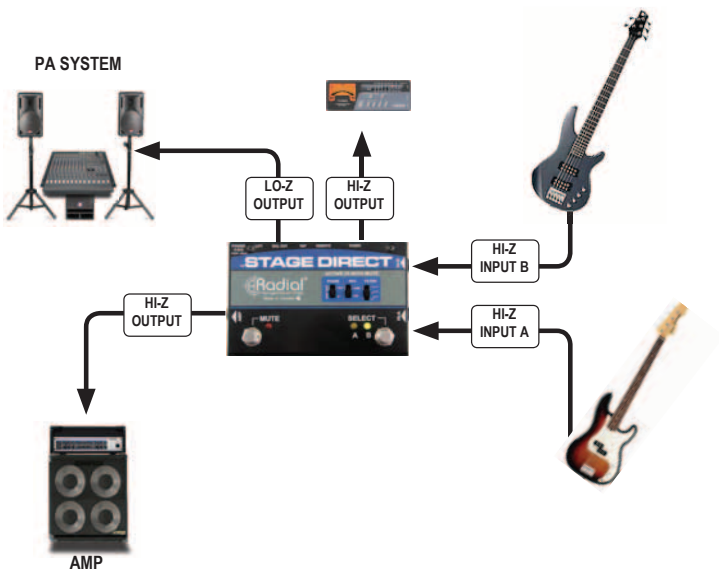

FEATURE SET



1. **POWER SUPPLY:** Use to connect the included power adapter (15VDC-400mA). StageDirect may also be powered by 48V phantom.
2. **LIFT:** Disconnects pin-1 on the XLR output to help eliminate hum and buzz caused by ground loops.
3. **BAL OUT:** Lo-Z balanced output used to feed the PA system. Follows standard AES format with pin-1 ground, pin-2 hot (+) and pin-3 cold (-).
4. **180°:** Reverses the polarity at the XLR output to help eliminate acoustic hot-spots on stage that can cause feedback.
5. **REMOTE:** Connection for a momentary (non-latching) footswitch that enables remote control of the mute function.
6. **PHASE:** Reverses the polarity at the 1/4" AMP output to help eliminate acoustic hot-spots on stage that can cause feedback.
7. **PAD:** Reduces the input sensitivity by -10dB to prevent overload from high output devices like keyboards and active pickups.
8. **TUNER:** Hi-Z 1/4" output allows you to connect an electronic tuner. It is always active and can be used for silent tuning with the mute footswitch.
9. **FILTER:** 3 position high-pass filter used to eliminate excessive bass to help reduce feedback and low frequency resonance.
10. **INPUTS:** Two hi-Z 1/4" inputs used to connect your instruments.
11. **SELECT:** Channel select switch with LED's indicating active channel.
12. **MUTE:** Mutes the stage amp and balanced XLR outputs, leaving the tuner output active for silent tuning.
13. **AMP:** Hi-Z 1/4" output is used to feed the on-stage guitar or bass amplifier. Transformer isolated to eliminate noise caused by ground loops.

GETTING STARTED

Before making any connections, always ensure your audio system is either turned down or turned off in order to protect more sensitive components from damage due to turn-on or plug-in transients.

48V PHANTOM OR AC ADAPTER

The Radial StageDirect is unique in that it may be powered using either 48V phantom from the PA system or by using the included 15VDC power supply. Most musicians will likely use phantom power as it is convenient. The 15VDC power supply gives you the option should phantom power not be available. A cable clamp is provided to lock down the power cable. Use a screw driver to loosen and loop the cable through before re-tightening the clamp. There is no power switch on the StageDirect. As soon as you plug in the power supply or turn on phantom power, it will come to life. One of the top panel LED indicators will illuminate to let you know power is being received.

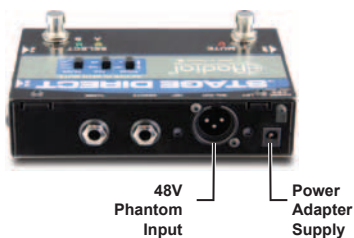

MAKING CONNECTIONS

Plug the hi-impedance (hi-Z) 1/4" instrument cable from your guitar or bass into the StageDirect INPUT A. Connect a standard low-impedance (lo-Z) XLR cable from the BALANCED OUT jack on the StageDirect to the PA system. If you are using a stage amp, connect a second hi-Z cable from the AMP output jack to your amplifier. The AMP output is transformer isolated to help eliminate noise caused by ground loops. For best results keep hi-Z instrument cables under 6 meters (20').



Connections for instrument, stage amp and PA system.

USING AND TESTING

Slowly bring up the level on the PA system. It is good practice to always test at a low volume to ensure proper connections have been made and all devices in the signal chain are working. This way, should a device not be turned on or a connector not fully pushed in, it will not create a loud transient 'pop' in the PA which in turn could blow a tweeter or annoy your audience. If you are using a stage amp, slowly turn up the volume and test it as well.

THE -10dB PAD

If you hear distortion, check to make sure the trim control on the PA is set correctly. If the problem persists, your instrument signal is likely overloading the StageDirect input. This can happen when connecting high-output electronic instruments like keyboards and bass guitars with active electronics. To eliminate distortion, engage the StageDirect's PAD using the switch on the top panel. When set to the -10dB position, this switch reduces the sensitivity of both instrument inputs.

THE TUNER OUTPUT

The StageDirect is equipped with a separate output for an electronic tuner. The tuner output is not affected by the MUTE footswitch and is always on to let you quickly adjust your tuning on the fly or in silence when the MUTE footswitch is engaged. The connection is made using a standard hi-Z 1/4" instrument cable.



Connecting a tuner.

USING THE MUTE FOOTSWITCH

The top mounted mute footswitch adds another dimension by enabling you to turn off the signal going to your stage amp and the PA system by simply depressing the footswitch. Once muted, the tuner output remains active to let you tune in silence without bothering the audience.

The mute footswitch also lets you silently disconnect a guitar or bass to exchange instruments on stage. This is particularly beneficial as it eliminates the need to set your amp on standby or have the audio engineer turn down your channel on the PA system each time you want to change instruments. When the outputs are muted, the red LED adjacent to the footswitch will illuminate.



USING THE REMOTE MUTE

The StageDirect may also be remotely muted using a 1/4" tip-sleeve momentary (non-latching) footswitch. These are available from your local music store and are often used as a sustain pedal for an electronic piano.



Radial JR-1M™ momentary footswitch.

Simply plug the momentary footswitch 1/4" connector into the REMOTE input jack to test. The local footswitch on the StageDirect will continue to function allowing you to control the mute function from either footswitch.

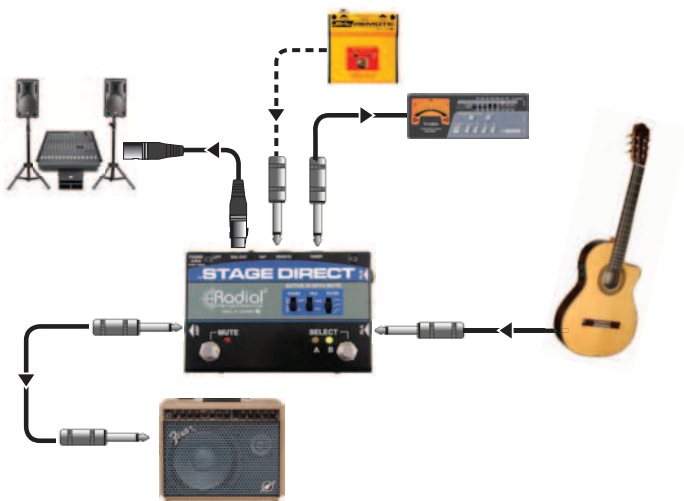

Remote footswitch connection.

VARIOUS REMOTE MUTE SETUPS

The remote footswitch can be used in a few different ways depending on your setup. For instance, you could locate the StageDirect off-stage with your amplifier and use the remote footswitch on your pedalboard.

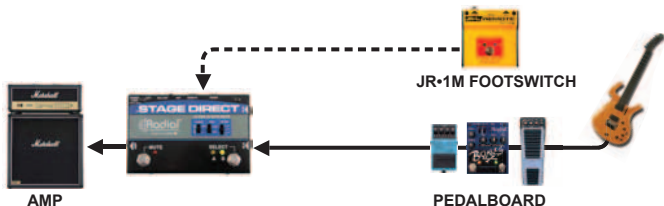

You could also have your guitar tech do the switching by locating the remote footswitch off-stage. This lets him swap guitars in between songs without missing a beat.



Players who use a wireless system with their instruments can locate the remote mute on the front line and keep the StageDirect with their amplifier setup in a tidy package on the backline.

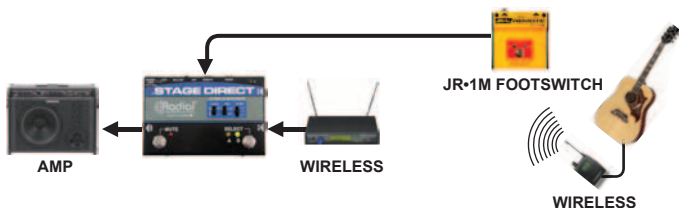

You could also use a MIDI controller equipped with momentary contact closure output to remotely mute the StageDirect as part of a larger MIDI switching setup. The StageDirect's remote mute function opens doors that were previously closed!

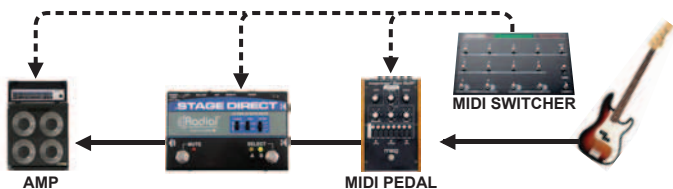

REMOTE SWITCHING WITH THE RADIAL SW2™ FOOTSWITCH

For even more control over your system you can employ the optional Radial SW2 footswitch. This features two footswitches that can operate the mute function on the StageDirect and one other device that has a footswitch input. For instance you can employ the second footswitch to change channels on your stage amp or turn an effects unit on and off. You can even link the SW2 footswitches together and trigger the second device at the same time the StageDirect mutes or unmutes. The SW2 is powered by a standard 9 volt adaptor (not included).



The SW2 supports both 'latching' and 'pulse' footswitch signals, thus enabling the SW2 to control older amplifiers with contact closure type switching and newer electronics and amps with pulse sensing switching.

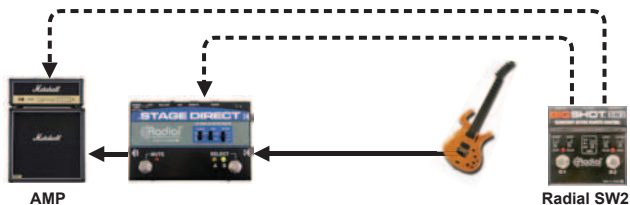

The SW2 can connect to the StageDirect to control the mute function and to an amp's channel switching footswitch.

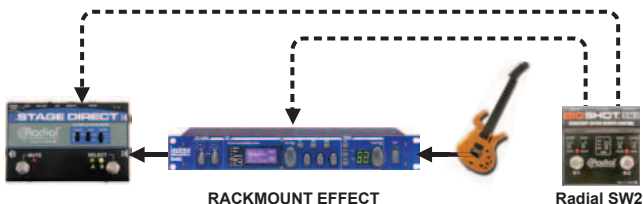

The SW2 can connect to the StageDirect to control the mute function and to an effect such as a rackmount digital reverb.

MANAGING FEEDBACK

The StageDirect has two built-in features that are designed to help reduce resonant feedback when using an acoustic instrument on stage. These include a high-pass (low cut) filter and 180° polarity reverse switches.

High-pass Filter

A powerful feedback fighting feature is the built-in high-pass filter. This 3-position switch lets you remove low frequencies from the signal path to eliminate resonance and 'size the instrument'. In other words, smaller instruments like a mandolin, do not produce very low frequencies so removing unused bass can prevent resonance and achieve more gain before the onset of feedback.

Removing unneeded low frequencies from the instrument signal also helps tremendously by cleaning up the mix. This rids the PA from warbling effects as various frequencies modulate together which can cause the mix to sound muddy and instruments indistinct.



The top filter setting is FLAT or BYPASS. Use this setting when you don't want any low frequencies removed from your signal. This works well for acoustic/electric bass and full range devices like keyboards.

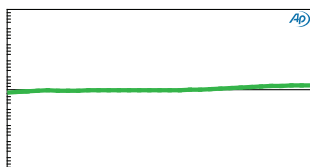

Setting 1: Flat or bypass

The middle filter setting gently rolls off low frequencies below 60Hz. Use this setting when you want to remove the very low end of your signal. This works well with acoustic guitar to sound natural while achieving more gain before feedback.

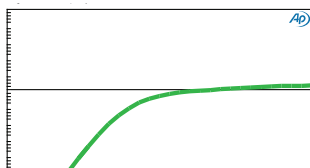

Setting 2: -3dB at 60Hz

The bottom filter setting also rolls off low frequency at a gentle rate but the effect starts at the higher 200Hz mid-bass frequency range. Use the bottom setting with an instrument that does not produce a lot of low frequencies like violin or mandolin to achieve a cleaner, tighter sound with improved gain before feedback.

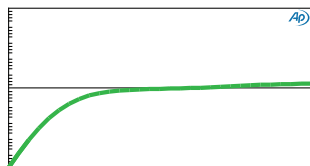

Setting 3: -3dB at 200Hz

Using the 180° polarity reverse

Resonant feedback generally occurs when a powerful low-frequency wave on stage causes the top of the instrument to vibrate. This low frequency wave may be produced by the stage monitors, PA system, stage amp or a combination as they interact together in the acoustic space. When two waves from different speakers collide in phase they can increase in amplitude causing a resonant peak or 'hot spot' on stage. If this hot spot happens to be where you are standing your instrument will likely begin to feedback.

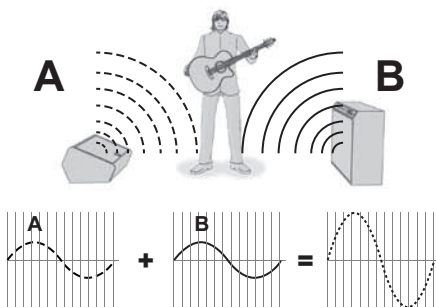

In-phase frequencies from the floor monitor (A) and the stage amp (B) combine and create a feedback hotspot.

By changing the polarity (or relative phase) of the direct box output, one of the two waves can be inverted which will cause phase cancellation and instead of a hot spot, it creates a 'null'. You can often use this technique to electronically move the resonant frequency out of the way and achieve more gain before the onset of feedback.

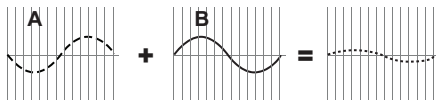

Inverting the polarity of the XLR output reverses the phase of the floor monitor (A) and creates a null when combined with the stage amp (B).

The StageDirect has two 180° polarity reverse switches. One is for the lo-Z XLR output and reverses pin-2 and pin-3. The other is on the hi-Z AMP output and reverses the phase of the signal going to your amp. Try changing the polarity going to the PA first, then your stage amp to find the combination that works best.

180° inverts the polarity of the lo-Z XLR output.



Phase inverts the polarity of the hi-Z 1/4" AMP output.

ELIMINATING HUM AND BUZZ

Solving noise problems on stage is a never ending battle! The StageDirect has been designed to minimize noise by incorporating a ground lift switch that disconnects the audio signal ground in a specific way, depending on which power source is being used.

Lifting the signal ground usually helps to reduce the hum and buzz caused by ground loops. When using the 15VDC supply, lifting the ground results in a true 100% ground lift by disconnecting pin-1 on the XLR output. When using phantom power, lifting the pin-1 ground also disconnects the 48V DC supply. As such, when powered by 48V phantom, the StageDirect employs a quasi ground lift scheme that provides a virtual ground lift, while still enabling phantom power to pass.

If noise is encountered after connecting the XLR, simply depress the recessed ground lift switch using a small screwdriver.



Recessed ground lift switch for the XLR output located on the rear panel.

To further reduce the opportunity for noise to pollute the audio system, the hi-Z 1/4" stage amp output is equipped with a transformer. Isolating the stage amp from the StageDirect and PA helps eliminate hum and buzz caused by ground loops.

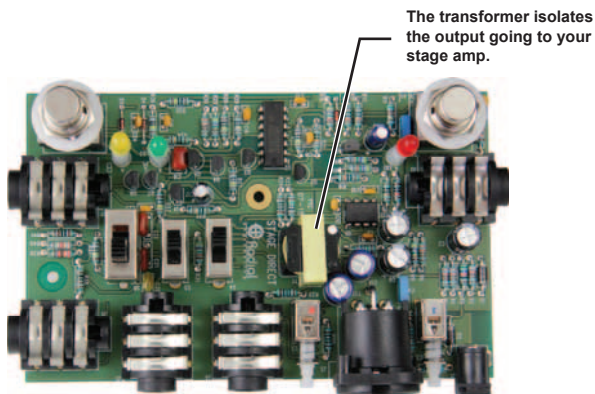

The transformer isolates the output going to your stage amp.

SPECIFICATIONS*

Audio circuit type:Active Buffer with class-A FET front end
 Frequency response: 20Hz ~ 20kHz
 Total harmonic distortion: <0.01%
 Dynamic range: 100dB
 Instrument input impedance: 250k Ohms
 Maximum input: +13dBu
 XLR output impedance: 250 Ohms
 Equivalent input noise: -87dBu
 Intermodulation distortion:..... 0.012%
 Phase deviation: 8° at 50Hz
 XLR configuration: Pin 1 ground, Pin 2 (+), Pin 3 (-)
 Remote switch:..... Momentary (pulse) ¼" contact closure
 Power:48V phantom or 15V/400mA power adapter
 Construction: 14 gauge steel chassis and outer shell
 Finish:.....Durable powder coat
 Warranty:Radial 3-year, transferable

*Specifications are subject to change without notice.

BLOCK DIAGRAM

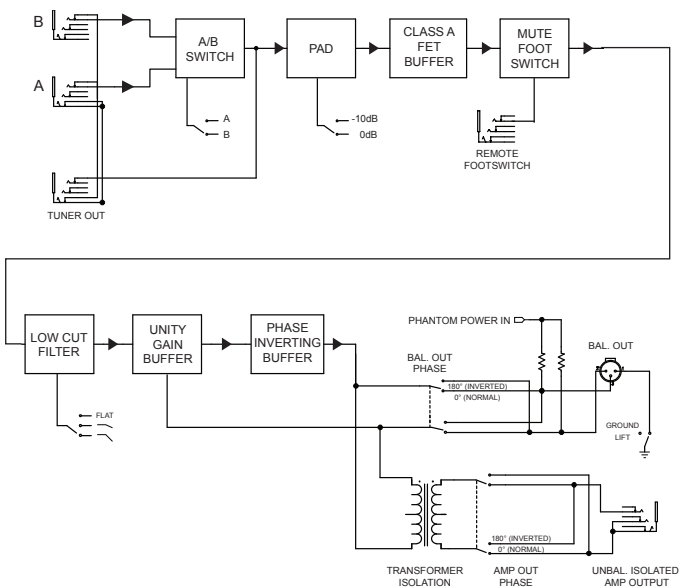

THREE YEAR TRANSFERABLE LIMITED WARRANTY

RADIAL ENGINEERING LTD. ("Radial") warrants this product to be free from defects in material and workmanship and will remedy any such defects free of charge according to the terms of this warranty. Radial will repair or replace (at its option) any defective component(s) of this product (excluding finish and wear and tear on components under normal use) for a period of three (3) years from the original date of purchase. In the event that a particular product is no longer available, Radial reserves the right to replace the product with a similar product of equal or greater value. In the unlikely event that a defect is uncovered, please call 604-942-1001 or email service@radialeng.com to obtain an RA number (Return Authorization number) before the 3 year warranty period expires. The product must be returned prepaid in the original shipping container (or equivalent) to Radial or to an authorized Radial repair center and you must assume the risk of loss or damage. A copy of the original invoice showing date of purchase and the dealer name must accompany any request for work to be performed under this limited and transferable warranty. This warranty shall not apply if the product has been damaged due to abuse, misuse, misapplication, accident or as a result of service or modification by any other than an authorized Radial repair center.

THERE ARE NO EXPRESSED WARRANTIES OTHER THAN THOSE ON THE FACE HEREOF AND DESCRIBED ABOVE. NO WARRANTIES WHETHER EXPRESSED OR IMPLIED, INCLUDING BUT NOT LIMITED TO, ANY IMPLIED WARRANTIES OF MERCHANTABILITY OR FITNESS FOR A PARTICULAR PURPOSE SHALL EXTEND BEYOND THE RESPECTIVE WARRANTY PERIOD DESCRIBED ABOVE OF THREE YEARS. RADIAL SHALL NOT BE RESPONSIBLE OR LIABLE FOR ANY SPECIAL, INCIDENTAL OR CONSEQUENTIAL DAMAGES OR LOSS ARISING FROM THE USE OF THIS PRODUCT. THIS WARRANTY GIVES YOU SPECIFIC LEGAL RIGHTS, AND YOU MAY ALSO HAVE OTHER RIGHTS, WHICH MAY VARY DEPENDING ON WHERE YOU LIVE AND WHERE THE PRODUCT WAS PURCHASED.



www.radialeng.com

Radial Engineering Ltd.
1588 Kebet Way, Port Coquitlam BC V3C 5M5
tel: 604-942-1001 • fax: 604-942-1010
info@radialeng.com • www.radialeng.com



Radial® StageDirect™ User Guide - Part# R870 1234 00
Specifications and appearance are subject to change without notice.

Made in Canada 